

PALMSENS 4™

Operator's Manual

Version 06-2026-007



If you have problems

First make sure to check the “Troubleshooting” section in this document and the Knowledge Base on our website: www.palmsens.com/knowledgebase/
This page contains support information on installation, software updates, and training.

Please make sure your software and firmware are up-to-date.



In case of persistent problems:

Use the contact form: www.palmsens.com/contact/

Give us a call: +31 30 2459211

Or send an email: info@palmsens.com

Try to describe the problem as detailed as possible. Sending us the relevant method files, data files and screenshots can be helpful.

Please include your instrument model and serial numbers, as well as any applicable software and firmware version you are using.

Limited Warranty

Except as otherwise provided herein, PalmSens BV warrants to buyer three years from the date title to the product passes (transfer date of goods from seller to buyer), each product sold hereunder will be free of defects in materials or workmanship and will conform to specifications set forth in PalmSens BV’s published data sheets or, where applicable, user manuals for PalmSens BV’s system products in effect at the time title passes.

PalmSens BV’s sole liability and responsibility for products under this warranty is for PalmSens BV to repair or replace any product that is returned to it by buyer or credit buyer’s account for such returned product, provided that PalmSens BV shall have the right to reject any such remedy where PalmSens BV determines that the warranty does not apply. Products returned to PalmSens BV for warranty service will be shipped to PalmSens BV at buyer’s expense and will be returned to buyer at PalmSens BV’s expense. PalmSens BV’s obligation to honor its warranty for a product is contingent upon receipt of payment in full for such product.

See our website for more detailed information:

www.palmsens.com/terms-and-conditions/

Disclaimers

PalmSens BV is not liable for any direct, indirect, incidental, or consequential damages resulting from the use or misuse of its instruments, including but not limited to:

- Damage to the instrument caused by improper handling, unauthorized modifications, or use outside the recommended specifications.
- Malfunction or incorrect results due to improper sample preparation, contamination, or incorrect experimental setup.
- Loss of data or research results caused by software crashes, hardware failures, or power interruptions.
- Personal injury or property damage resulting from incorrect wiring, exposure to hazardous chemicals, or misuse of electrical connections.

Results obtained using PalmSens instruments depend on experimental conditions, sample properties, and user expertise. Users are responsible for verifying the validity of their data.

Changes in specifications and typing errors reserved. Every effort has been made to ensure the accuracy of this document. However, no rights can be claimed by the contents of this document.

By using PalmSens instruments, the user acknowledges and accepts these limitations and responsibilities.

See Appendix A for CE declaration of conformity.

Copyrights

PalmSens4 Operator's Manual.

Copyright © 2024-2026, PalmSens BV, all rights reserved.

PSTrace, MultiTrace, Nexus, PalmSens, EmStat, MultiEmStat and Sensit are trademarks of PalmSens BV.

No part of this document may be copied or reproduced in any form without the prior written consent of PalmSens BV.



Contents

1	Introduction.....	1
1.1	The scope of this manual	1
1.2	About the PalmSens4.....	2
2	Operating the PalmSens4	3
2.1	USB and charging	3
2.2	Bluetooth.....	4
2.3	Cell connections.....	4
2.4	Display and power indicator	5
2.5	iR Compensation	5
2.6	BiPotentiostat	7
2.7	Auxiliary port pin-out	8
2.8	Cell connector pin-out.....	9
3	Specifications.....	11
3.1	EIS contour accuracy plot	13
4	Troubleshooting	15
4.1	Running self-diagnostics	15
4.2	Verifying your potentiostat.....	15
4.3	Noise.....	16
5	Self-Diagnostics	17
6	Performing a hard reset.....	19
7	Battery replacement.....	23
8	Maintenance and compliance	25
8.1	Lithium-Polymer batteries.....	25
8.2	Temperature compliance.....	25
8.3	Humidity compliance.....	26
8.4	Temperature drift.....	26
8.5	Atmospheric pressure.....	26
8.6	Cleaning.....	26
8.7	Periodic calibration and preventive maintenance.....	26
8.8	Service and repair.....	26
8.9	RoHS Compliance.....	26
A.	EU Declaration of conformity.....	27

B. EU Waste Electrical and Electronic Equipment (WEEE) Directive28

1 Introduction

1.1 The scope of this manual

This manual covers the handling, characteristics, troubleshooting, and other practical information regarding the hardware specifics of the PalmSens4, as well as maintenance and compliance.

Please refer to the **Quick Installation Guide** that was supplied with the instrument for instructions on installing the instrument and the software. Additionally, the section **Getting Started** in the digital **PSTrace Manual**, that is installed with the software, provides detailed instructions for conducting first measurements with your instrument.



Initial setup and basic operational instructions for conducting initial measurements are detailed in the “Quick Installation Guide” supplied with the instrument.

The PSTrace Manual is an in-depth document covering not only the PSTrace software but also the hardware limitations for each technique supported by the instrument. It is written to give you a full understanding of both the software and hardware aspects, making sure you're well-equipped to use all the functionalities of the PalmSens4.

1.2 About the PalmSens4

The PalmSens4 is a hand-held battery powered instrument for use with electrochemical sensors or electrochemical cells. The instrument is a low noise and low-current potentiostat and galvanostat which controls the potential or current applied to the sensor and measures the current or potential response.

The PalmSens4 is on the market since 2016. Main new features added to the PalmSens4, compared to the PalmSens3, includes a color display, internal storage, and improved FRA for Electrochemical Impedance Spectroscopy (EIS).

Features

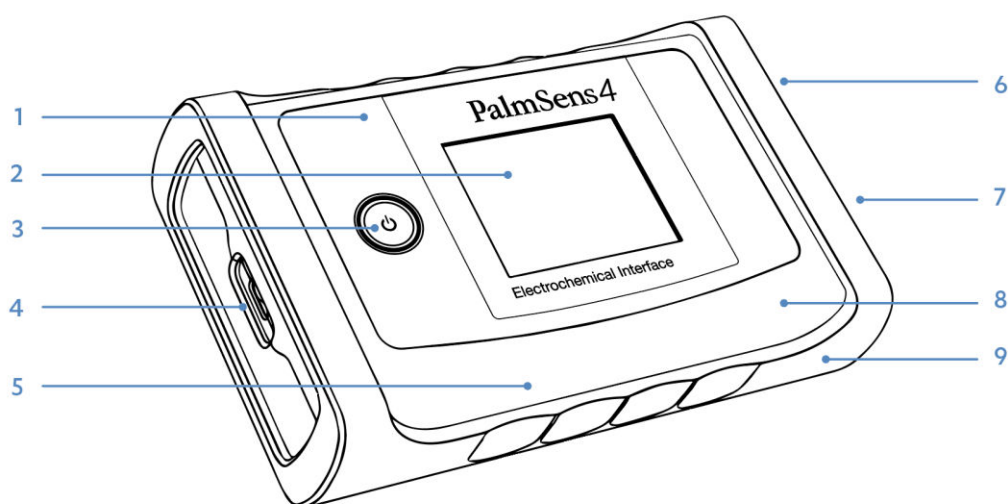

1. Dual Mode Bluetooth
2. Color display
3. Power button with illuminated indicator ring
4. USB-C port
5. 3000 mAh Li-Po battery
6. LEMO cell connector
7. DB-15 Auxiliary connector
8. 16 GB internal storage memory
9. Rubber protection sleeve

2 Operating the PalmSens4

The PalmSens4 can be used either on battery using a wireless Bluetooth connection or by connecting it via its USB-C port to a PC or Android device. Switch on the PalmSens4 by pressing the power button for a couple of seconds.

2.1 USB and charging

The PalmSens4 has a USB Type-C (USB-C) port and uses the High-Speed USB 2.0 specification. The PalmSens4 can be used with any common USB port.

For optimal performance, PalmSens recommends using only the shielded USB-C to USB-A (standard rectangular plug) cable supplied as standard with the instrument. Use of other or longer cables may increase susceptibility to electromagnetic interference and may affect measurement performance. Similarly, if feasible, it is recommended to refrain from utilizing a USB hub or docking station.



Figure 1 PalmSens4 connected via USB.

A full charge of the PalmSens4 takes about 8 hours. Any USB power source can be used for charging.

2.1.1 USB Y-Cable

If the PalmSens4 is fitted with a "BiPot module" to utilize a second working electrode, it may demand more than 500 mA, exceeding the USB 2.0 standard's maximum current for ports. However, in practice, the majority of USB ports on PCs typically offer more than 500 mA. To ensure sufficient power for the PalmSens4 when operating as a bi-potentiostat, an additional USB Y-cable is supplied for extra power. Refer to Figure 2 for an illustration of the USB Y-cable.



Figure 2 USB Y-Cable for extra power in case of using the BiPot module.



The BiPot module decreases the battery life of the PalmSens4 in idle mode (cell off) down to ~ 5 hours.

2.2 Bluetooth

Every PalmSens4 has a unique Bluetooth identifier. The Bluetooth identifier of the PalmSens instrument can be found on the bottom of the display when the instrument is idle. The Bluetooth identifier always starts with the letters PS, followed by the last 4 characters of its MAC address. For example: PS-6AEF. See Figure 3 for an illustration.

When connecting to the USB port of a PC, Bluetooth will switch off automatically unless there is a Bluetooth connection active. This allows the instrument to be charged via the PC while a Bluetooth connection is present.

In case a pairing code is requested by the host (PC or Android device), use the pairing code 1234. If you experience issues with the Bluetooth connection, refer to section: "Connecting using Bluetooth" in the PSTrace Manual.

2.3 Cell connections

The cell cable is connected to the PalmSens4 by means of a LEMO push-pull connector. Make sure the red dot on the connector is facing upwards when plugging the connector into the PalmSens4.

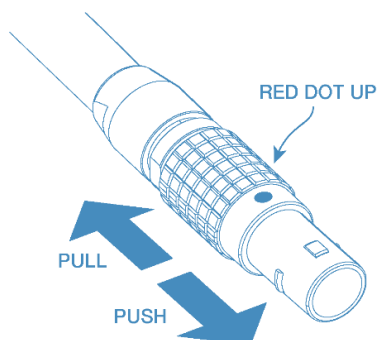

The PalmSens4 cell connector is a push-pull connector. Do not try to twist it!

For more information about making a connection to the cell, see also section: “Connecting a cell to the potentiostat” in the PSTrace Manual.

2.4 Display and power indicator

The PalmSens4 has a color display and illuminated white ring around the power button to indicate the instrument is powered on.

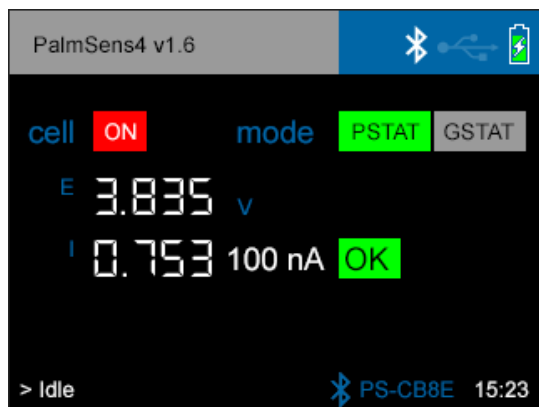

Figure 3 PalmSens4 display when in idle mode.

In idle mode (not running a measurement), the display shows the following contents:

- Firmware version
- Connection status (Bluetooth or USB)
- Battery status
- Cell status (ON/OFF)
- Potential controlled mode (PSTAT) or current controlled mode (GSTAT)
- Potential readings (E)
- Current readings (I)
- Bluetooth identifier
- Time

For every reading during idle mode, the < > sign in the bottom left corner flips to indicate the instrument is actively running.

The time is updated whenever the instrument connects to PSTrace (Windows) or PStouch (Android). The time is used together with the date for timestamping data on the internal storage.

2.5 iR Compensation

The PalmSens4 iR Compensation module is an optional extension available for the PalmSens4 potentiostat. It needs to be ordered concurrently with the new instrument, or alternatively, it can be installed later at the factory.

This module operates through Positive Feedback, achieved using a 16-bit MDAC in the module which scales the output of the current follower to provide a positive feedback voltage that is proportional to the current through the cell. The compensation voltage is added to the summing point before the control amplifier and thus increases (or decreases) the applied potential to counteract the iR drop.

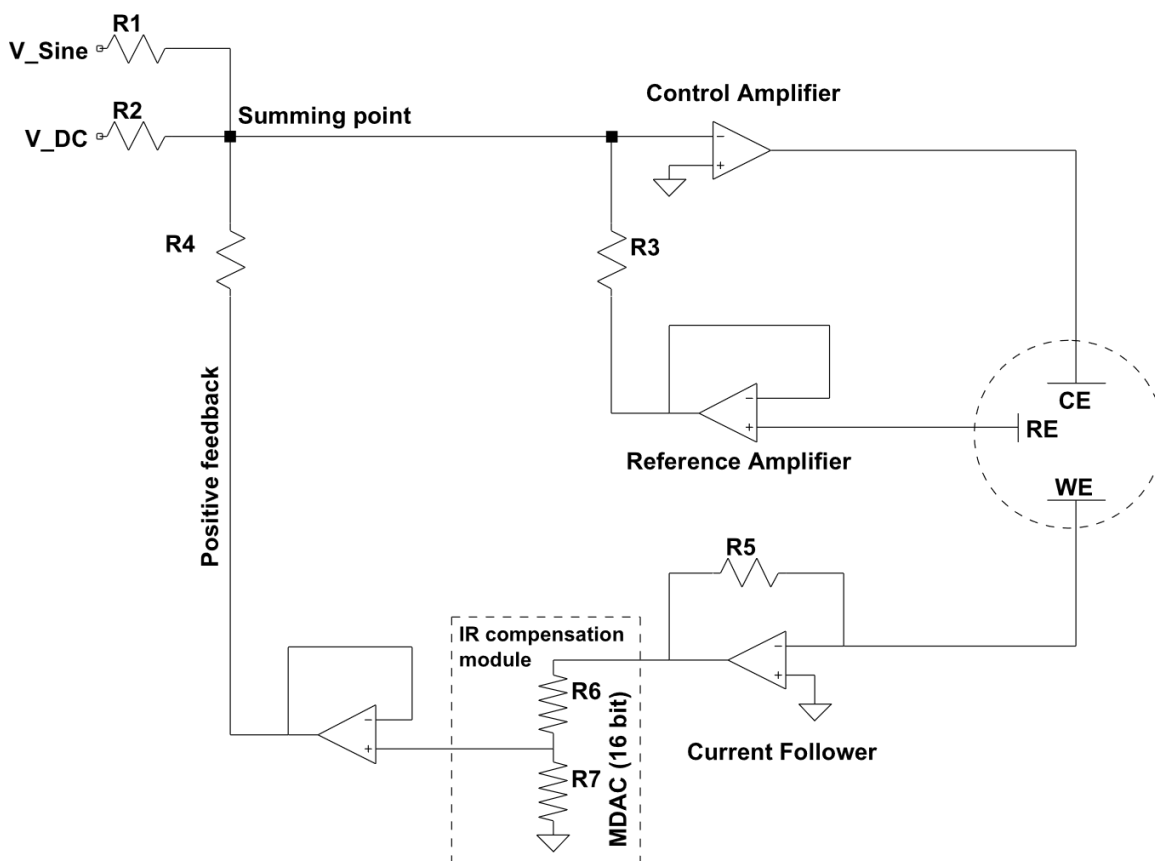

Figure 4 Simplified schematical representation of iR compensation circuitry in the PalmSens4

Positive feedback allows for fast scan rates up to 10 V/s, depending on the characteristics of the cell. If the potential error to compensate for becomes close to the value set for E applied, the system might become unstable. Using iR compensation limits the measurement bandwidth to 10 kHz.

See also section: “Ohmic (iR) compensation” in the PSTrace Manual, and our application note: “iR Compensation and Uncompensated Resistance”.

2.6 BiPotentiostat

“BiPot” stands for BiPotentiostat, which is a potentiostat with two working electrodes.

A bipotentiostat can use two working electrodes, one reference and one counter in the same cell. The two working electrodes can be operated and monitored exactly at the same time.

Working electrode 1 performs any of the supported techniques (see below), while working electrode 2 can either have its own constant potential or follow the working electrode 1's potential. In the latter case a potential offset can be added.

2.6.1 Application examples

- Second electrode as a blank or similar in the same cell for comparison
- Detecting the product of the disc electrode's reaction at the ring of a RRDE (Rotating Ring Disc Electrode)
- Polarize the surface during scanning electrochemical microscopy (SECM)
- Controlling gate voltage and source-drain voltage of an ion selective field effect transistors (ISFET)

2.6.2 Supported techniques for use with bipotentiostat

The following techniques are supported for PalmSens4 equipped with the BiPot module:

- Linear Sweep Voltammetry
- Cyclic Voltammetry
- Amperometric Detection
- Multistep Amperometry

Please refer to section “Using a BiPot” in the PStTrace Manual, for more information.

2.7 Auxiliary port pin-out

The following schematic and table show the PalmSens4 auxiliary port pin-out and pin functions.

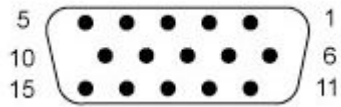

Figure 5 The front view of the female port (DE-15) on the PalmSens4.

Table 1 PalmSens4 auxiliary port pin functions.

Pin	Function
1	d0 digital output (5V)
2	d3 digital output (5V)
3	analog input -10 to +10 V, 18 bit, >0.5 MΩ input impedance
4	RESERVED
5	RESERVED
6	d1 digital output (5V)
7	d0 digital input (5V)
8	i monitor given as -V in active current range.
9	5V digital power line (max. 300mA)
10	digital ground
11	d2 digital output (5V)
12	RESERVED (NC)
13	E out (-10 to +10V)
14	analog ground
15	analog out (0 to 10 V at 12 bit), 1 kΩ output impedance
Connector housing	digital ground

2.8 Cell connector pin-out

The following schematics show the PalmSens4 cell connector pin-out and pin functions.

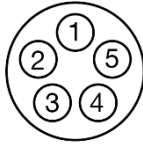

Figure 6 Front view of the female cell connector on the PalmSens4.

Table 2 Cell connector pin functions of the PalmSens4.

Pin	Function	Connector color
1	Reference Electrode (RE)	Blue
2	Reference Electrode Shield	N/A
3	Counter / Auxiliary Electrode (CE)	Black
4	Working Electrode 2 / BiPot (WE2) (if BiPot module is installed)	Yellow
5	Working Electrode (WE)	Red
Connector housing	Analog Ground (AGND)	Green

3 Specifications

The following tables show the main specifications of the PalmSens4.

Table 3 PalmSens4 specifications

General			
dc-potential range	config	PS4.F#.05 ±5 V	PS4.F#.10 ±10 V
compliance voltage	±10 V		
maximum current	±30 mA (typical)		
Potentiostat (controlled potential mode)			
applied dc-potential resolution	76.3 μ V (18-bit)		
applied potential accuracy	≤ 0.1% ±1 mV offset		
current ranges	100 pA to 10 mA (9 ranges)		
measured current accuracy	< 0.2% of current ±10 pA ±0.1% of range		
measured current resolution	0.005% of current range (18-bit, 5 fA on 100 pA range) 0.0025% of 10 mA range		
Galvanostat (controlled current mode)			
current ranges	1 nA to 10 mA (8 ranges)		
applied dc-current	±6 x applied current range		
applied dc-current resolution	0.0076% of applied range (<10 mA) 0.0038% of 10 mA range		
potential ranges	10 mV, 100 mV, 1 V		
measured dc-potential resolution	78 μ V at ±10 V (1 V range, 18-bit) 7.8 μ V at ±1 V (100 mV range) 0.78 μ V at ±0.1 V (10 mV range)		
measured dc-potential accuracy	≤ 0.05% or ±1 mV (for E < ±9 V) ≤ 0.2% (for E ≥ ±9 V)		

FRA / EIS (optional)	
frequency range	config PS4.F1.## PS4.F2.## 10 μ Hz to 100 kHz 10 μ Hz to 1 MHz
ac-amplitude range	1 mV to 0.25 V rms, or 0.7 V p-p

Electrometer	
electrometer amplifier input	> 1 T Ω // 10 pF
bandwidth	1 MHz

BiPotentiostat (optional)	
dc-potential range	± 5 V
dc-potential resolution	153 μ V
dc-offset error	$\leq 0.1\%$ ± 1 mV offset
accuracy	$\leq 0.1\%$
current ranges	100 pA to 10 mA (9 ranges)
maximum measured current	$i(\text{WE1}) + i(\text{WE2}) < 30$ mA
current resolution	0.005% of current range (5 fA on 100 pA range) 0.0025% of 10 mA range

Other	
electrode connections	2 mm banana pins for RE, WE, CE and GND
housing	aluminium body with rubber sleeve: 15.7 x 9.7 x 3.5 cm ³
weight	~500 g
temperature range	0 °C to +50 °C
power supply	USB or internal LiPo battery
communication	Bluetooth and USB-C (recommended USB cable: supplied shielded USB-C to USB-A cable)
battery	11.1 Wh capacity > 16 hours idle time (> 5 hours with BiPot installed) > 4 hours with cell on at max. current Extendible by means of power bank
internal storage space	16 GB (or >200 million data points)

3.1 EIS contour accuracy plot

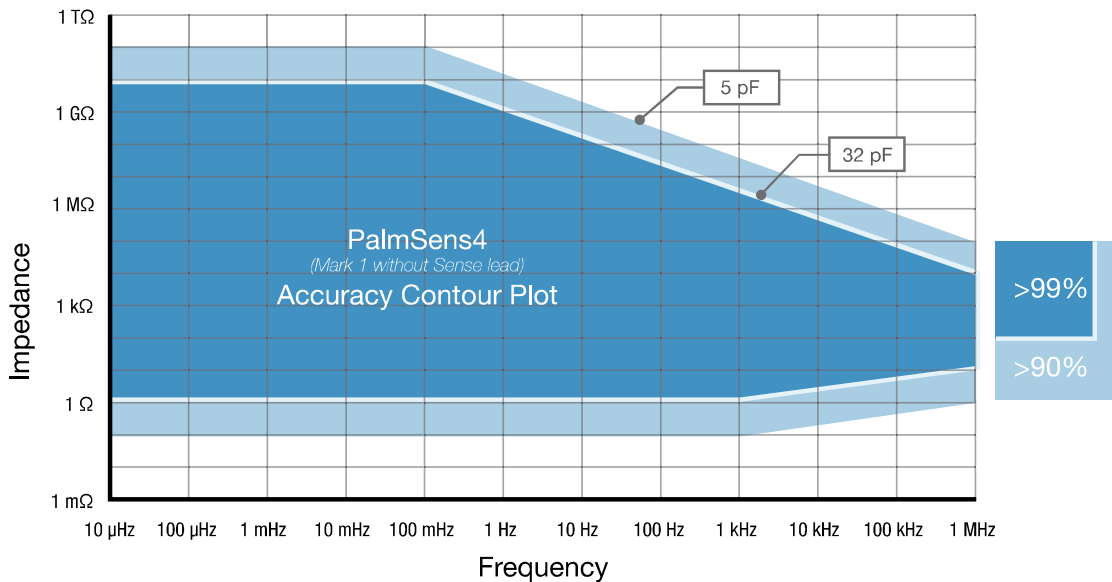

Figure 7 EIS contour accuracy plot for the PalmSens4

Note: The accuracy contour plot was determined under lab conditions and should be used for reference purposes. Please note that the true limits of an impedance measurement are influenced by all components in the system, e.g. cables, the environment, and the cell.

4 Troubleshooting

4.1 Running self-diagnostics

The PalmSens4 has a built-in diagnostics tool which can be executed in PStace. This tool generates a detailed report showing any issues which might be present in the hardware.

See for more information section: Self Diagnostics on page 17.

4.2 Verifying your potentiostat

Your instrument can be tested by using the test sensor or dummy cell supplied with the instrument.

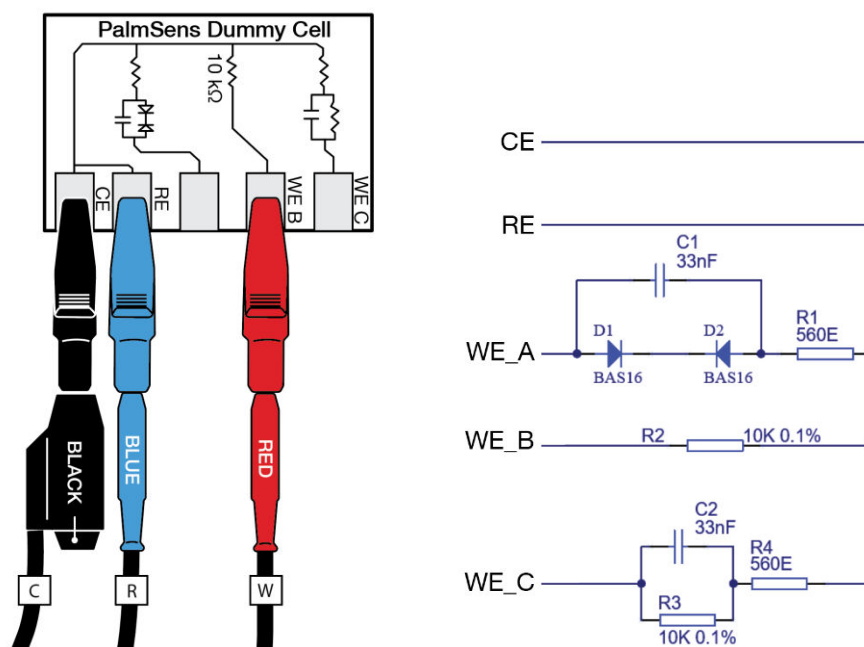

Figure 8 PalmSens Dummy Cell

The easiest way to verify the functioning of your instrument is to use the “WE B” circuit, which consists of a resistor with a value of 10 kΩ with a max deviation of 0.1%.

The WE lead is connected to one side and both RE and CE to the other side of the resistor.

Any of the electrochemical techniques can be applied. The current response obtained with a resistor with value R is equal to the applied potential or potential pulse divided

by the value of R. So, if a potential of 0.5 V is applied on a resistor of 10 k Ω , the obtained current should be $0.5 \text{ V} / 10 \text{ k}\Omega = 50 \text{ }\mu\text{A}$.

Contact PalmSens BV if the problems are found: info@palmsens.com and report the problems as detailed as possible.

4.3 Noise

Our instruments are designed with hardware noise suppression filters to reject noise from internal and external sources. If a higher level of noise is your issue, the solving strategies are rather numerous, but the sources for noise are also numerous. Here we describe the most successful and common methods for noise reduction.

To determine the noise levels for your instrument, please refer to section "Measuring the noise level of the instrument" of the PSTrace Manual.

4.3.1 Power grid

Your power grid is usually using an alternating current. This undulating current influences the measured currents. PSTrace and PStouch have a filter for this mains frequency. In PSTrace, check in the 'Tools' menu under 'General Settings' if the mains frequency is set correctly (50 Hz or 60 Hz).

4.3.2 Electrical fields

Our environment is filled with electrical fields. Some of them are created by devices around us as side effects or in case of wireless communication on purpose. Although it is a bad idea to measure directly next to an electric arc furnace, it is usually not possible to have a workspace free of electrical fields, especially not during point-of-care measurements.

Nearby RF transmitters (Wi-Fi routers, mobile phones, industrial radios) may be interpreted by the instrument as valid electrochemical signals. Measurements performed near such sources may therefore deviate from stated specifications.

A Faraday cage is usually sufficient to create a field-free environment. A metal box or cage out of metal mesh is a good Faraday cage. Even a shield out of aluminum foil can help. Place your electrochemical cell inside the Faraday cage and connect the cage to the ground lead (green) of the potentiostat. The cable delivered with your instrument has an inbuilt shield and should protect your signal outside the Faraday cage. This is one of the most effective methods to reduce noise.

4.3.3 Cables

For optimal electromagnetic compatibility (EMC) and to minimise radiated or conducted interference, PalmSens recommends using only the supplied shielded USB cable. Longer or third-party USB cables may behave as antennas and increase susceptibility to external electromagnetic fields, potentially affecting noise levels and measurement performance.

4.3.4 Contacts

Check if the contacts are corroded. If so, remove the stains, for example with sandpaper.

5 Self-Diagnostics

PalmSens4 supports self-diagnostics from firmware v1.7 and on. Check the PalmSens4 LCD or the Instrument Settings window in PSTrace to see which firmware version the instrument is running. The 'Self Diagnostics Tool' generates a report that gives a detailed overview of possible malfunctions. This report can be exported to a Word document and sent by email (info@palmstens.com) to PalmSens BV in case there's doubt about the functioning of your PalmSens4.

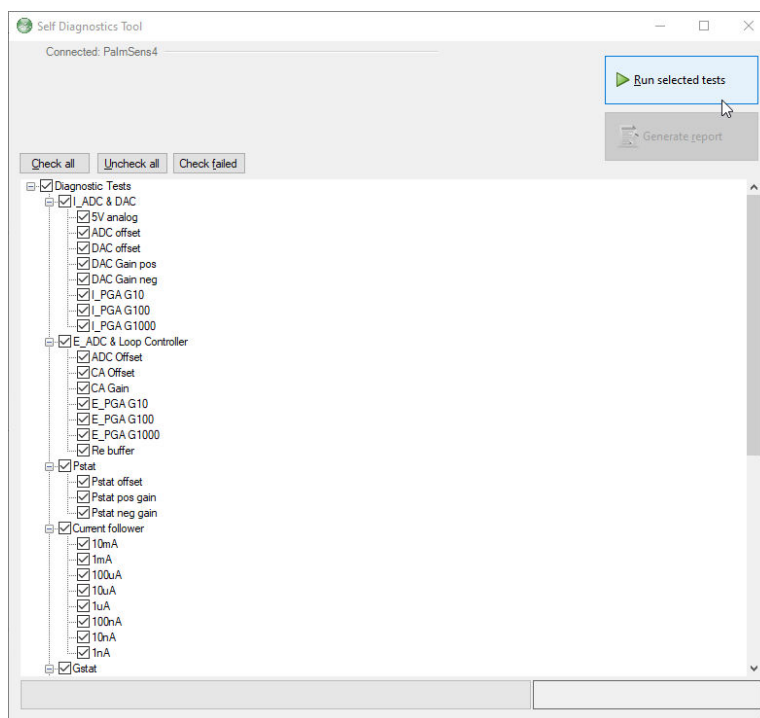

Figure 9 The 'Self Diagnostics Tool' window

To run the self-diagnostics tool go to the menu: 'Tools' → 'Instrument Settings...' and click the button 'Self Diagnostics'. Follow the instructions shown on the screen.

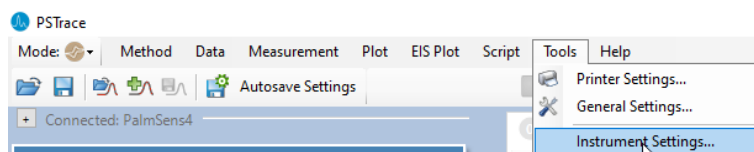
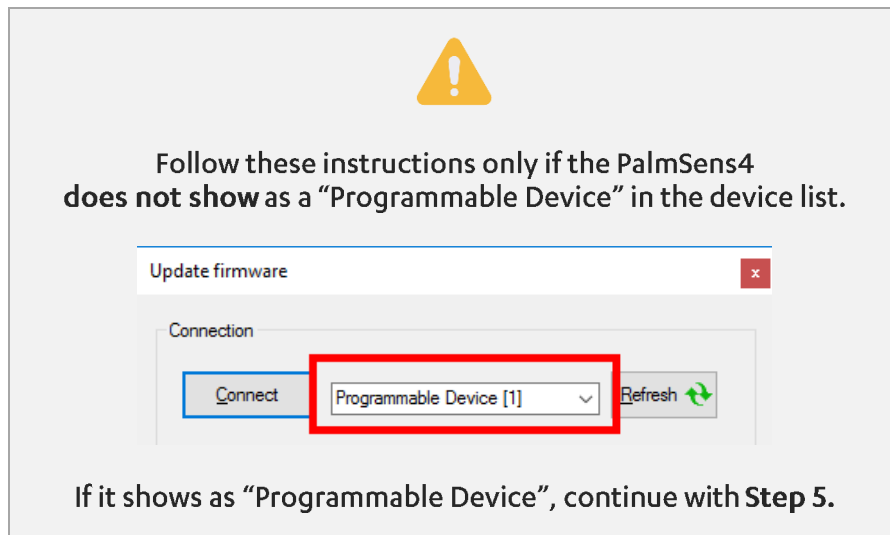

Figure 10 Menu 'Instrument Settings' found in 'Tools'

6 Performing a hard reset

The instructions in this section should be followed if the PalmSens4 is in a state where the LCD remains black after switching on and the instrument does not show up in the list with instruments in PSTrace or the Firmware Update program as “PalmSens4” or as “Programmable Device”.



Required tools:

- Screwdriver: Torx 8
- Paperclip

Step 1: Remove battery lid and battery



Figure 11 PalmSens4 with the battery lid removed.

Step 2: Connect the PalmSens4 to USB

Connect the PalmSens4 to your PC with the USB cable. Place the PalmSens4 up-side-down on your desk.

Step 3: Short the two 'Rst' pads

Bend the paperclip in such a way that you can short the two 'Rst' pads in the battery compartment, as shown in the photo below.

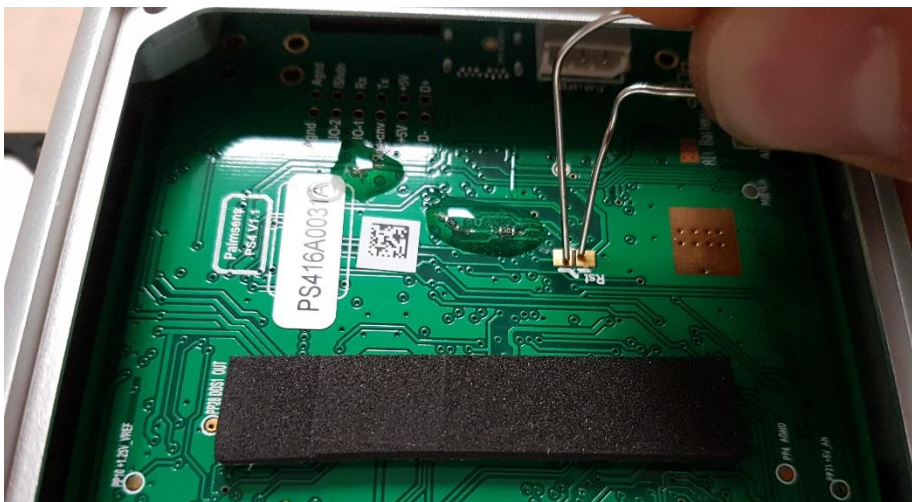

Figure 12 Shorting the two 'Rst' pads on the PalmSens4 for recovery.

Step 4: Unplug and plug back in

Remove the USB cable from the PalmSens4, wait a few seconds and then connect the PalmSens4 back to the PC again.

Step 5: Upload new firmware

- Open PSTrace and go to menu: Tools → Instrument Settings... and click button "Update firmware".

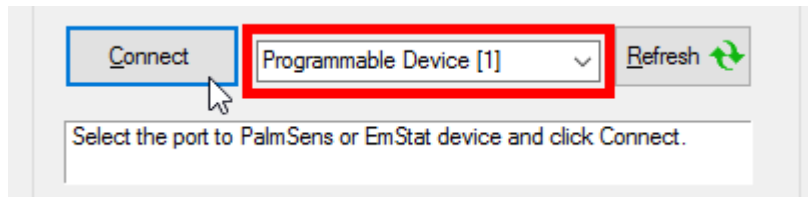

Figure 13 PalmSens4 listed as 'Programmable Device'

- You should see "Programmable Device" selected next to the "Connect" button.
- Click "Connect"
- Click "Browse" and select file "PalmSens4_firmware_v###.hex"

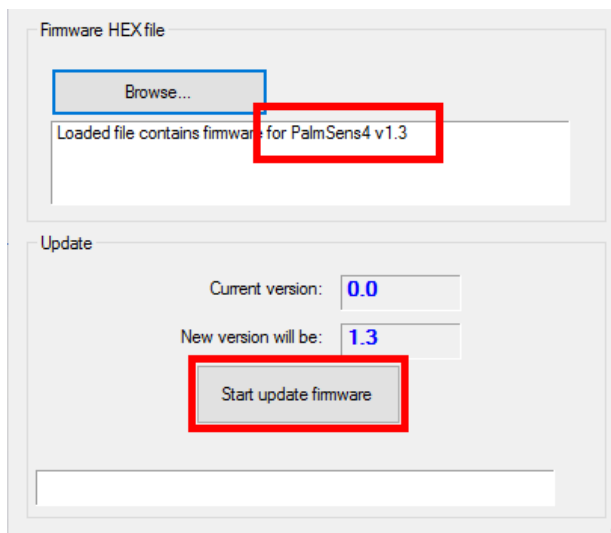
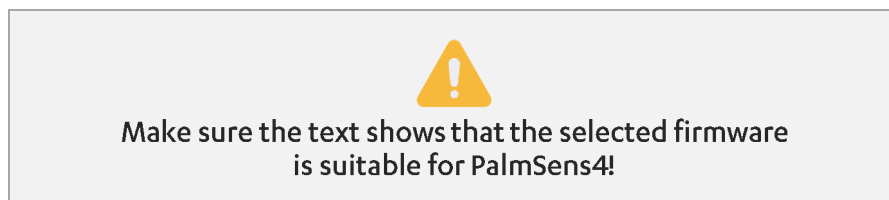

Figure 14 Verifying the loaded firmware and the button to start the update procedure.

- Make sure the text shows it is firmware suitable for PalmSens4.



- Click the button “Start update firmware”.

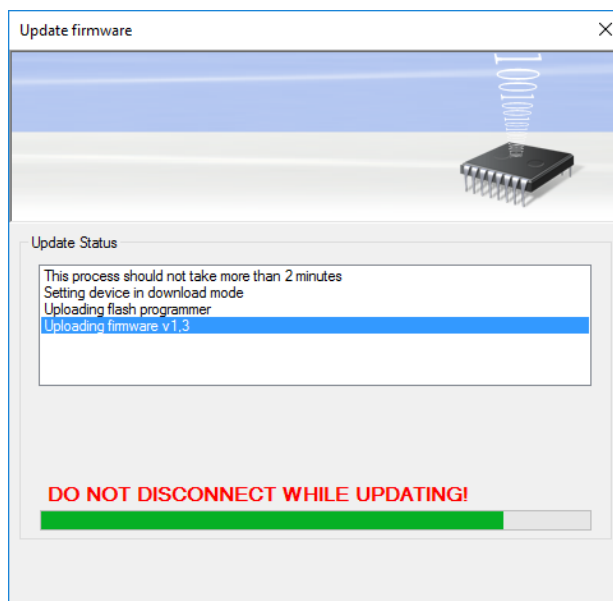

Figure 15 The firmware upload progress window.

- Wait until the Uploader gives the message “UPDATE COMPLETE” and close the window.

Step 6: Place the battery

Connect the 3000 mAh battery and place it in the battery compartment with the wires folded at the side of the battery.

Step 7: Close housing

Put the lid and the gasket back in place and close the housing. Double-check that the rubber gasket is placed in the right orientation to ensure proper sealing. Do not use excessive force when tightening the screws.

7 Battery replacement

Required:

- Screwdriver: Torx 8
- 3000 mAh LiPo battery acquired from PalmSens BV

Step 1: Open the battery compartment

Unscrew the four screws and remove the battery lid and gasket. Then gently pull on the battery connector to disconnect it.



Figure 16 PalmSens4 with the battery lid removed.

Step 2: Place new battery

Connect the new 3000 mAh battery as received from PalmSens BV and place it in the battery compartment with the wires folded at the side of the battery.



The use of an unauthorized battery may compromise safety, pose a risk of fire, and result in irreversible damage to the device.

Step 3: Close housing

Put the lid and the gasket back in place and close the housing. Double-check that the rubber gasket is placed in the right orientation to ensure proper sealing. Do not use excessive force when tightening the screws.

8 Maintenance and compliance

8.1 Lithium-Polymer batteries

The typical estimated life of a Lithium-Polymer battery is about two to three years or 300 to 500 charge cycles, whichever occurs first. One charge cycle is a period of use from fully charged, to fully discharged, and fully recharged again. Consider a two-to-three-year life expectancy for batteries that do not run through complete charge cycles.

Rechargeable Lithium-Polymer batteries have a limited life and will gradually lose their capacity to hold a charge. This loss of capacity (aging) is irreversible. As the battery loses capacity, the length of time it will power the product (run time) decreases. Lithium-Ion batteries continue to slowly discharge (self-discharge) when not in use or while in storage.

Detailed instructions for battery replacement can be found in this document.

The new battery or battery pack must be obtained from PalmSens BV. Lithium-ion batteries have specific voltage operation and temperature control requirements, so using the wrong model may lead to overheating and fire.



The use of an unauthorized battery may compromise safety, pose a risk of fire, and result in irreversible damage to the device.

8.2 Temperature compliance

Our instruments are designed for indoor use at ambient temperatures between 0 °C and 45 °C. All the components of PalmSens products (except their batteries) are rated to the industrial temperature standard of -40 °C to +85 °C.

The battery of the PalmSens4 is rated -20 °C to +60 °C when discharging 0 °C to +45 °C when charging.

8.3 Humidity compliance

PalmSens instruments have not been tested in high humidity environments.

Elevated humidity however may cause measurement errors if condensation forms on the electronics. This affects measurements in the nA ranges or lower. Prolonged exposure to a condensing environment may severely decrease the life expectancy of the instrument and void its warranty.

8.4 Temperature drift

PalmSens instruments are calibrated at 21 °C. The most sensitive components of the instrument have temperature drift of 50 ppm. For instance at 1 °C or 41 °C, measurement drift of up to 0.1% may be experienced.

8.5 Atmospheric pressure

PalmSens instruments are not intended for use in safety-critical applications. Consequently, the power supplies utilized are not selected based on a specific pressure rating.

8.6 Cleaning

Make sure to disconnect your instrument from any cell or power source, if applicable, prior to cleaning. Use a cloth lightly dampened with either clean water or water containing a mild detergent to clean the outside of the instrument. Alternatively, you can use isopropyl alcohol. Avoid using a wet rag and prevent any fluids from entering the instrument. It is crucial not to immerse the instrument in any cleaning solution.

8.7 Periodic calibration and preventive maintenance

PalmSens instruments are designed in a way that eliminates the need for periodic calibration. While not mandatory, PalmSens does provide a calibration service for users with specific demands such as QC/ISO purposes. This service includes a new calibration certificate.

It's important to note that PalmSens instruments do not require preventive maintenance, further simplifying their use and reducing the overall maintenance demands on users.

8.8 Service and repair

Except for the battery in some models, your PalmSens instrument contains no user-serviceable parts internally. Any service or maintenance needs should be directed to a qualified service technician employed by PalmSens BV. Attempting to access or modify internal components without proper expertise may result in additional damage to the instrument and void warranties. It is recommended to rely on authorized service personnel for any required maintenance or repairs.

8.9 RoHS Compliance

All instruments from PalmSens have been built using lead free components and lead-free solder. They are in compliance with the European RoHS initiative.

A. EU Declaration of conformity



EU DECLARATION OF CONFORMITY

Certificate number: PSDOC-PS4-B



Manufacturer: PalmSens BV
Address: Vleugelboot 22,
3991 CL Houten,
The Netherlands

This declaration is valid for the following product:

PalmSens4 (PS4 V1.4 and higher)

Portable electrochemical analyser

- USB power and communications
- Battery power
- Bluetooth communication
- Screen display
- 1 meter cell cable

The object of the declaration described above is in conformity with the Radio Emissions Directive 2014/53/EU (RED) and applicable standards listed below:

Health & Safety

- EN 62479
- EN 61010-1

EMC

- EN 61326-1
- EN 301 489 parts 1 & 17

Efficient Usage of Radio Spectrum

- EN 300 328

This declaration is issued under the sole responsibility of PalmSens BV.

Date: 29th of November 2023

A handwritten signature in black ink, appearing to read "C.J. van Velzen", written over a horizontal line.

C.J. van Velzen, CTO

B. EU Waste Electrical and Electronic Equipment (WEEE) Directive



The pictogram shown above, located on the product(s) and / or accompanying documents means that used electrical and electronic equipment (WEEE) should not be mixed with general household waste. For proper treatment, recovery and recycling, please take this product(s) to designated collection points where it will be accepted free of charge.

Alternatively, in some countries, you may be able to return your products to your local retailer upon purchase of an equivalent new product. Disposing of this product correctly will help save valuable resources and prevent any potential negative effects on human health and the environment, which could otherwise arise from inappropriate waste handling. Please contact your local authority for further details of your nearest designated collection point. Penalties may be applicable for incorrect disposal of this waste, in accordance with your national legislation.

Published by

PalmSens BV
Vleugelboot 22
3991 CL Houten
The Netherlands

© 2026 PalmSens BV
All rights reserved.

